

INSTRUCTION MANUAL

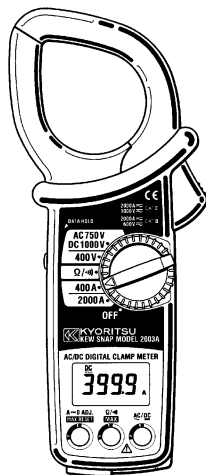

DIGITAL CLAMP METER

KEW SNAP SERIES

MODEL 2003A

 **KYORITSU**
ELECTRICAL INSTRUMENTS WORKS, LTD

Contents

1. Safety Warnings	1
2. Features	4
3. Specifications	5
4. Instrument Layout	8
5. Preparation for Measurement	11
5-1 Battery Voltage Check	11
6. Measurement	
6-1 DC Current Measurement	12
6-2 AC Current Measurement	14
6-3 DC Voltage Measurement	15
6-4 AC Voltage Measurement	16
6-5 Resistance Measurement	17
6-6 Continuity Check	18
6-7 MAX Measurement	19
7. Other Functions	
7-1 Sleep Function	20
7-2 Data Hold Function	21
7-3 OUTPUT Terminal	22
8. Battery Replacement	24
9. Optional Accessories	25

1. Safety Warnings

This instrument has been designed and tested according to IEC Publication 61010; Safety Requirements for Electronic Measuring Apparatus. This instruction manual contains warnings and safety rules which must be observed by the user to ensure safe operation of the instrument and retain it in safe condition. Therefore, read through these operating instructions before starting using the instrument.

⚠ WARNING

- Read through and understand instructions contained in this manual before starting using the instrument.
- Save and keep the manual handy to enable quick reference whenever necessary.
- Be sure to use the instrument only in its intended applications and to follow measurement procedures described in the manual.
- Be sure to understand and follow all safety instructions contained in the manual.

Failure to follow the above instructions may cause injury, instrument damage and/or damage to equipment under test

The symbol Δ indicated on the instrument means that the user must refer to related parts in the manual for safe operation of the instrument. Be sure to carefully read the instructions following each Δ symbol in this manual.

Δ DANGER is reserved for conditions and actions that are likely to cause serious or fatal injury.

Δ WARNING is reserved for conditions and actions that can cause serious or fatal injury.

Δ CAUTION is reserved for conditions and actions that can cause minor injury or instrument damage.

Δ DANGER

- Never make measurement on a circuit above 750VAC or 1000VDC.
- Do not attempt to make measurement in the presence of flammable gasses, fumes, vapor or dust. Otherwise, the use of the instrument may cause sparking, which can lead to an explosion.
- The transformer jaws are made of metal and their tips are not insulated. Where equipment under test has exposed conductive parts, be especially careful about the hazard of possible shorting. Not following this instruction may can danger to the user.
- Never attempt to use the instrument if its surface or your hand is wet.
- Do not exceed the maximum allowable input of any measurement range.
- Never open the battery compartment cover when making measurement

⚠ WARNING

- Never attempt to make any measurement, if the instrument has any structural abnormality such as cracked case and exposed metal part.
- Do not turn the Function Selector switch with test leads connected to the instrument.
- Do not install substitute parts or make any modification to the instrument. Return the instrument to your distributor for repair or re-calibration.
- Do not try to replace the batteries if the surface of the instrument is wet.
- Always switch off the instrument before opening the battery compartment cover for battery replacement

⚠ CAUTION

- Make sure that the Function Selector switch is set to an appropriate position before making measurement.
- Always make sure to insert each plug of the test leads fully into the appropriate terminal on the instrument.
- Be sure to set the Function Selector switch to the "OFF" position after use. When the instrument will not be in use for a long period of time, place it in storage after removing the batteries.
- Do not expose the instrument to the direct sun, extreme temperatures or dew fall.
- Use a damp cloth and detergent for cleaning the instrument. Do not use abrasives or solvents.

2. Features

- Tear-drop-shaped jaws for ease of use in crowded cable areas and other tight places
- Provides a wide measuring range from 0 up to 2000A
- Terminal cover to avoid the use of incorrect use of the input terminals.
- MAX measurement function for easy reading of maximum input over a certain period of time
- Output terminal for long term current monitoring
- Safety design throughout conforming to the following provisions of IEC61010
 - Pollution degree 2, overvoltage category III 600V
 - Pollution degree 2, overvoltage category II 1000V
- Data hold function to allow for easy readings in dimly lit or hard-to-read locations.
- Sleep feature to conserve battery power.
- Permits easy continuity check with a beeper
- Provides a dynamic range of 4,000 counts full scale
- Wide frequency range from 40Hz to 1kHz
- Transformer jaws fitted will guard to further improve safety

3. Specifications

Measuring Ranges and Accuracy (at $23\pm 5^{\circ}\text{C}$, 45 to 85%RH)

DC Current ---

Range	Measuring Ranges	Accuracy
400A	0 to $\pm 400.0\text{A}$	$\pm 1.5\% \text{rdg} \pm 2 \text{dgt}$
2000A	0 to $\pm 2000\text{A}$	

AC Current \sim

Range	Measuring Ranges	Accuracy
400A	0 to 400.0A	$\pm 1.5\% \text{rdg} \pm 2 \text{dgt} (50/60\text{Hz})$
2000A	0 to 1700A	$\pm 3.0\% \text{rdg} \pm 4 \text{dgt} (40 \sim 1\text{kHz})$
	1701 to 2000A	$\pm 3.0\% \text{rdg} \pm 2 \text{dgt} (50/60\text{Hz})$

DC Voltage (Input impedance: $2\text{M}\Omega$) ---

Range	Measuring Ranges	Accuracy
400V	0 to $\pm 400.0\text{V}$	$\pm 1.0\% \text{rdg} \pm 2 \text{dgt}$
1000V	0 to $\pm 1000\text{V}$	

AC Voltage (Input impedance: $2\text{M}\Omega$) \sim

Range	Measuring Ranges	Accuracy
400V	0 to 400.0V	$\pm 1.5\% \text{rdg} \pm 2 \text{dgt} (50/60\text{Hz})$
750V	0 to 750V	$\pm 1.5\% \text{rdg} \pm 4 \text{dgt} (40 \sim 1\text{kHz})$

Resistance (Auto-ranging)

Range	Measuring Ranges	Accuracy
400 Ω / 4000 Ω	0 to 4000 Ω	$\pm 1.5\% \text{rdg} \pm 2 \text{dgt}$

Resistance (Fixed)

Range	Measuring Ranges	Accuracy
400 Ω	0 \sim 400.0 Ω	$\pm 1.5\% \text{rdg} \pm 2 \text{dgt}$ (Buzzer beeps at $50 \pm 35\Omega$ of less)

OUTPUT Voltage(Output impedance: about 10kΩ)

	Accuracy	DC Output Voltages	Input Currents	Accuracy
DC	400A	0 to 400.0mV	0 to 400A	$\pm 1.5\% \text{rdg} \pm 3\text{mV}$
	2000A	0 to 200.0mV	0 to 2000A	$\pm 1.5\% \text{rdg} \pm 3\text{mV}$
AC	400A	0 to 400.0mV	0 to 400A	$\pm 1.5\% \text{rdg} \pm 3\text{mV}$ (50/60Hz) $\pm 3.0\% \text{rdg} \pm 3\text{mV}$ (40~1kHz)
		0 to 170.0mV	0 to 1700A	$\pm 1.5\% \text{rdg} \pm 3\text{mV}$ (50/60Hz) $\pm 3.0\% \text{rdg} \pm 3\text{mV}$ (40~1kHz)
	170.1 to 200.0mV	1701 to 2000A	$\pm 3.0\% \text{rdg} \pm 3\text{mV}$ (50/60Hz)	

※Electromagnetic compatibility (IEC61000-4-3)

:RF field strength = $\leq 1\text{V/m}$, total accuracy = specified accuracy

:RF field strength = 3V/m , total accuracy = specified accuracy +1% of range

- Operating System : Dual Integration
- Display : Liquid crystal display with maximum counts of 4000
- Low Battery Warning : "BATT" symbol is displayed on the digital display.
- Overrang Indication : "OL" is displayed where input exceeds the upper limit of a range
- Response Time : Approx. 2 seconds
- Sample rate : Approx. 2.5 times per second
- Temperature and Humidity for Guaranteed Accuracy : $23^{\circ}\text{C} \pm 5$, relative humidity up to 85% without condensation
- Operating Temperature and Humidity : 0 to 40°C , relative humidity up to 85% without condensation

- Storage Temperature and Humidity : -20 to 60°C, relative humidity up to 90% without condensation
- Power Source : Two R6P(DC1.5V) batteries or equivalent
- Current Consumption : Approx. 9mA max
- Sleep function : Automatically switches to the Sleep mode in about 10 minutes after the last switch or button operation (current consumption in the Sleep mode: about 20 μ A)
- Overload Protection : AC/DC current ranges 2400A AC/DC for 10sec
AC/DC current ranges 1200A AC/DC for 10sec
Resistance ranges 600V AC/DC for 10sec
- Withstand Voltage : 5500V AC for 1 minute
(between electrical circuit and housing cases or metal parts of jaws)
- Insulation Resistance : 10M Ω or greater at 1000V
(between electrical circuit and housing cases or , metal parts of jaws)
- Conductor Size : Approx. 55mm diameter max
- Dimensions : 250(L) \times 105(W) \times 49(D)mm
- Weight : Approx 530g
- Accessories : Test leads M-70171set
: R6P batteries2
: Carrying case M-90941
: Output Plug M-82011
: Instruction manual1
- Accessories : Multi-Tran M-8008
: Recorder M-5100A, etc
: Output Lead M-7014

4. Instrument Layout

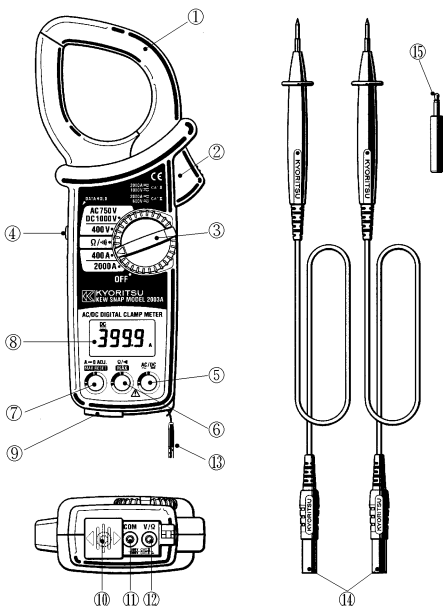

①Transformer Jaws : Include current sensors

②Jaw Trigger : Used to open and close the transformer jaws

③Function Selector Switch

Selects function to use. Also switches off the instrument when set to the "OFF" position.

④Data Hold Button

Freezes the display reading with **H** symbol shown on the display when pushed in.

⑤ AC/DC Button

Used to switch the instrument between the AC and DC modes. The instrument is set to the AC mode when it is powered on. Press this button to select the DC mode.

⑥ Mode Button

A press of this button on a current or voltage range turns the instrument to the MAX measurement mode with **MAX** shown on the display. Press the button again to exit the MAX mode.

A press of the button on the resistance range turns the instrument to the continuity check mode with \Rightarrow symbol shown on the display. In this mode, the buzzer beeps when the reading is about $50\ \Omega$ or less. Press the button again to exit the continuity check mode.

⑦ Zero ADJ./RESET Button

Used for zero adjustment on 400A DC range or for resetting the reading in the MAX mode. **AUTO** symbol is shown on the display when zero adjustment is enabled on 400A DC range. (Zero adjustment is available only on 400A DC range.)

⑧ LCD Display

Field effect type of liquid crystal display with maximum counts of 3999 and microprocessor-controlled annunciators and the decimal point.

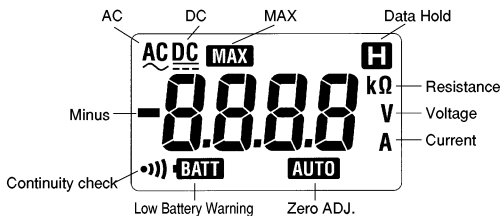

⑨ Terminal Cover

Used to enclose the input terminals (COM and V/Ω) when the OUTPUT terminal is in use, thus avoiding accidental application of voltage to the instrument.

⑩ OUTPUT Terminal (for current measurement only)

Provides DC voltage in proportion to the reading on an AC or DC current range. The voltage is used for such purposes as long term monitoring with a recorder or other recording devices. This terminal cannot be accessed on a voltage or resistance range.

⑪ COM Terminal

Accepts the black test lead for voltage or resistance measurement.

⑫ V/Ω Terminal

Accepts the red test lead for voltage or resistance measurement.

⑬ Safety Hand Strap

Prevents the instrument from slipping off the hand during use.

⑭ Test Leads (M-7017)

Connect to COM and V/Ω Terminal terminals for resistance measurement.

⑮ Output Plug (M-8201)

Insert this plug into the OUTPUT terminal to obtain DC output voltage. Connect suitable connection cord to the plug when it is used.

5. Preparation for Measurement

5-1 Checking Battery Voltage

Set the Function Selector switch to any position other than "OFF".

When the display is clear without **BATT** showing, proceed to measurement.

When the display blanks or **BATT** is shown, replace the batteries according to section 8: **Battery Replacement**

NOTE

The Sleep function automatically turns the instrument off in a certain period of time after the last switch operation. Therefore, the display may be blank with the Function Selector switch set to a position other than "OFF".

To operate the instrument in this case, set the switch back to the "OFF" position, then to the desired position, or press any button. If the display still blanks, the batteries have exhausted. Replace the batteries.

5-2 Checking Switch Setting

Make sure that the Function Selector switch is set to the correct position, the instrument is set to the correct mode and the Data Hold function is deactivated. Otherwise, desired measurement cannot be made.

6. Measurement

6-1 DC Current Measurement

⚠ DANGER

- Do not make measurement on a circuit above 1000V DC. This may cause shock hazard.
- Do not make measurement with the battery compartment cover removed from the instrument.
- Do not make current measurement with the test leads connected to the instrument.

- Set the Function Selector switch to the "400A" position and press the AC/DC button to select the DC mode. "DC" should be shown on the upper left corner of the display.
- With the transformer jaws closed without clamping them onto the conductor, press the Zero ADJ. button for about one second to zero adjust the display. (The Zero ADJ button is enabled only on 400A DC range.) **AUTO** should be shown on the display.
- Set the Function Selector switch to the position appropriate for the order of the current under test.

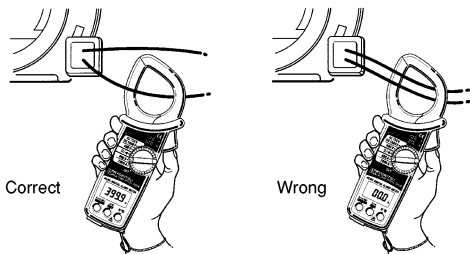

d. Press the trigger to open the transformer jaws and clamp them onto the conductor under test and take the reading on the display

NOTE

- ◇ During current measurement, keep the transformer jaws fully closed. Otherwise, accurate measurement cannot be made. The maximum measurable conductor size is 55mm in diameter.

- ◇ When the current flows from the upside (the display side) to the underside of the instrument, the polarity of the reading is positive and vice versa.

- ◇ The output voltage from the OUTPUT terminal may not reduce to nil even if the display is zero adjusted with the Zero ADJ button. In this case, make zero adjustment on the recorder or other device that the output voltage is connected to.

6—2 AC Current Measurement

⚠ DANGER

- Do not make measurement on a circuit above 750V AC. This may cause shock hazard.
- Do not make measurement with the battery compartment cover removed from the instrument.
- Do not make current measurement with the test leads connected to the V/ Ω and COM terminals

- Set the Function Selector switch to the "400A" or "2000A" position and select the AC mode. If the instrument is in the DC mode, press the AC/DC button once to select the AC mode. (The instrument is set to the AC mode when it is powered on.) "AC" should be shown on the upper left corner of the display.
 - Press the trigger to open the transformer jaws and clamp them onto the conductor under test and take the reading on the display.
- ◇ During current measurement, keep the transformer jaws fully closed. Otherwise, accurate measurement cannot be made. The maximum measurable conductor size is 55mm in diameter.
 - ◇ Unlike in DC current measurement, zero adjustment is not necessary in AC current measurement. There is no polarity in the reading either

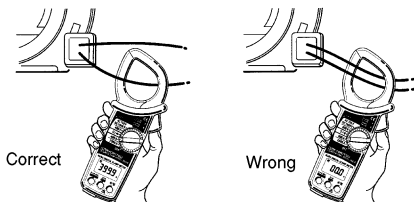

6—3 DC Voltage Measurement

⚠ DANGER

- Do not make measurement on a circuit above 1000V DC. This may cause electric shock hazard.
- Do not make measurement with the battery compartment cover removed

- Set the Function Selector switch to the "400V" or "1000V" position.
- Slide the terminal cover to the left. Plug the red test lead into the V/ Ω terminal and the black test lead into the COM terminal.
- Connect the other end of the tip of the red test lead the positive side of the circuit under test and the tip of the black test lead to the negative side. Take the reading on the display. If the test lead connection is reversed, the "-" sign is shown on the display.

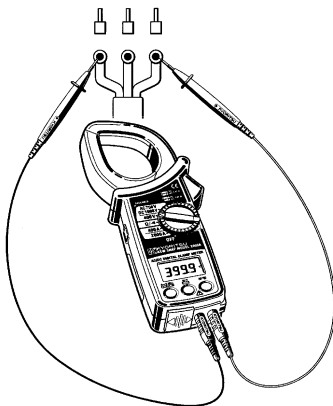
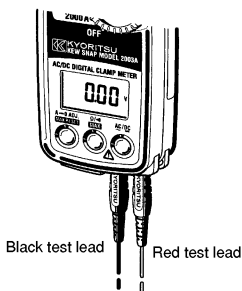

6—4 AC Voltage Measurement

△ DANGER

- Do not make measurement on a circuit above 1000V DC. This may cause electric shock hazard.
- Do not make measurement with the battery compartment cover removed

- Set the Function Selector switch to the "400V" or "750V" position. If the instrument is in the DC mode, press the AC/DC button once to select the AC mode. (The instrument is set to the AC mode when it is powered on.) The "AC" should be shown on the upper left corner of the display.
- Slide the terminal cover to the left. Plug the red test lead into the V/ Ω terminal and the black test lead into the COM terminal.
- Connect the tip of the test leads to the circuit under test. Take the reading on the display.

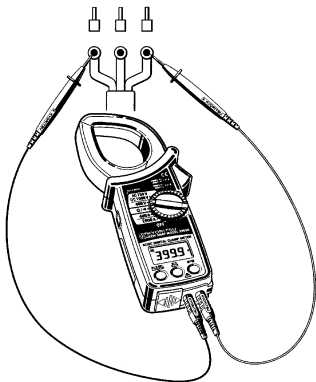
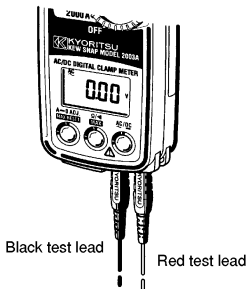

6—5 Resistance Measurement

⚠ DANGER

- Never try to make measurement on a circuit that is not de-energized.
- Do not make measurement with the battery compartment cover removed

- Set the Function Selector switch to the ($\Omega / \text{}$) position.
- Slide the terminal cover to the left. Plug the red test lead into the V/ Ω terminal and the black test lead into the COM terminal.
- Check that the display reads "OL". Then, short the tip of the test leads together and check that the display reads "0".
- Connect the tip of the test leads to the circuit under test and take the reading on the display.

NOTE

- ◇ When the tip of the test leads is shorted together, the display may read a very small resistance instead of "0". This is the resistance of the test leads, not a fault.
- ◇ If one of the test leads has a break, the display reads "OL".

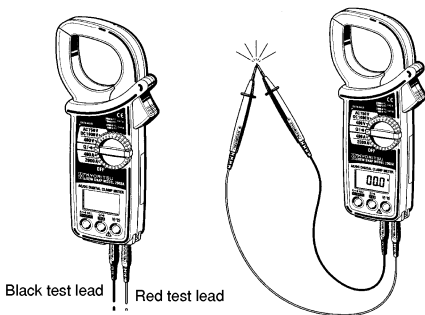

6-6 Continuity Check (Fixed 400 Ω range)

⚠ DANGER

- Never try to make measurement on a circuit that is not de live.
- Do not make measurement with the battery compartment cover removed.

- Set the Function Selector switch to the ($\Omega / \text{蜂}$) position.
- Slide the terminal cover to the left. Plug the red test lead into the V/ Ω terminal and the black test lead into the COM terminal.
- Press the mode button to select the continuity check mode. The 蜂 symbol should be shown on the display
- Check that the display reads "OL". Then short together the tip of the test leads and make sure that the display reads "0" and the buzzer beeps
- Connect the tip of the test leads to the circuit under test. The buzzer beeps when the resistance is about 50 Ω or less.

NOTE

- ◇ When the tip of the test leads is shorted together, the display may read a very small resistance instead of "0". This is the resistance of the test leads, not a fault.
- ◇ If one of the test leads has a break, the display reads "OL".

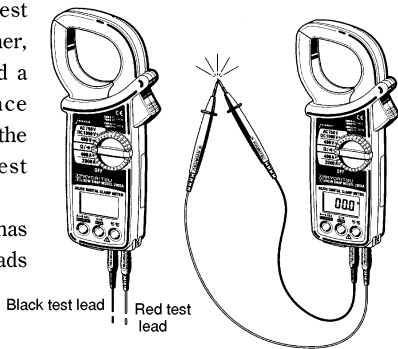

6—7 MAX Measurement (Response time: 400ms)

The MAX measurement mode is used to display a maximum reading over a certain period of time. This function is available on all ranges other than Ω ranges.

⚠ DANGER

- Do not make measurement on a circuit above 750V AC or 1000V DC. This may cause electric shock hazard.
- Do not make measurement with the battery compartment cover removed.
- Do not make measurement with the test leads connected to the instrument.

- a. Set the Function Selector switch to the desired position.
- b. Press the Mode button to select the MAX measurement mode.
MAX should be shown on the display.
- c. In order to take a correct reading, press the Zero Adjust/Reset button once after clamping the jaws onto the conductor or connecting the test leads to the circuit under test.
- d. The display shows the maximum reading during measurement
- e. Press the Zero Adjust/Reset button once again to return to the normal measurement mode.

NOTE

- ◇ Data Hold function is disabled in MAX measurement mode.
- ◇ For measurement over a period more than 10 minutes, disable the Sleep function according to the instruction in section 7-1: **Sleep Function**. Otherwise, the instrument automatically turns itself off in about 10 minutes.

7. Other Functions

7-1 Sleep Function

NOTE

The instrument consumes small amount of current in the Sleep (power-down) mode. Make sure to turn the Function Selector switch to the "OFF" position, when the instrument is not in use.

This is a function to prevent the instrument from being left powered on in order to conserve battery life. This function causes the instrument to switch to the Sleep (powered-down) mode about 10 minutes after the last switch or button operation.

To exit the Sleep mode, press any button or turn the Function Selector switch back to "OFF", then to any other position.

[How to disable the Sleep function]

Powering the instrument on with the Data Hold button pressed disables the Sleep function. "P.OFF" is shown on the display for about 3 seconds to indicate this.

To enable the Sleep function, turn the Function Selector switch back to "OFF", then to any other position.

NOTE

◇The Sleep function is disabled while the output plug is inserted into the OUTPUT terminal. When the output plug is disconnected from the terminal, the Sleep function is enabled in about 10 minutes.

7—2 Data Hold Function

This is a function used to freeze the measured value on the display. Press the Data Hold button to freeze the reading. The reading will be held regardless of the subsequent variation of current, voltage or resistance under test. **h** is shown on the upper right corner of the display.

To exit the Data Hold mode, press the Data Hold button again.

NOTE

- ◇The Data Hold mode is disabled when the instrument switches to the Sleep mode.
- ◇The Data Hold function is disabled in the MAX measurement mode.

7-3 OUTPUT Terminal (For current measurement only)

⚠ DANGER

- Do not make measurement on a circuit above 750V AC or 1000V DC. This may cause electric shock hazard.
- Do not make measurement with the battery compartment cover removed.
- Never apply voltage to the OUTPUT terminal.

- a. To obtain output voltage from the OUTPUT terminal, connect a suitable cord to the supplied output plug.

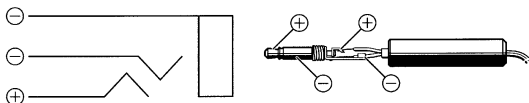

- b. Slide the terminal cover to the right to enclose the COM and V/ Ω terminals.

Insert the output plug into the OUTPUT terminal for connection with a recorder or other recording device.

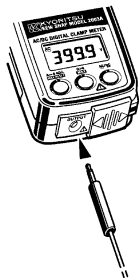

- c. Set the Function Selector switch to the "400A" or "2000A" position. (The output is available only in the two ranges.) Proceed to measurement in the DC or AC mode.

NOTE

- ◇ During current measurement, keep the transformer jaws fully closed. Otherwise, accurate measurement cannot be made. The maximum measurable conductor size is 55mm in diameter.
- ◇ Unlike in DC current measurement, zero adjustment is not necessary in AC current measurement. There is no polarity in the

reading either.

- ◇ In the DC mode, the output voltage from the OUTPUT terminal may not reduce to nil even if the display is zero adjusted with the Zero ADJ button. In this case, make zero adjustment on the recorder or other device that the output voltage is connected to.
- ◇ The Sleep function is disabled while the output plug is inserted into the OUTPUT terminal. When the output plug is disconnected from the terminal, the Sleep function is enabled in about 10 minutes.
- ◇ Set the appropriate sensitivity on the recorder or other recording device. See section 3 for output voltage specifications.

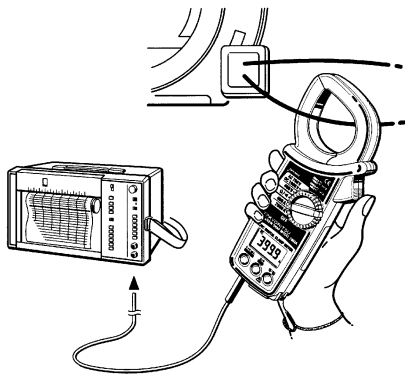

8. Battery Replacement

⚠ WARNING

- To avoid electric shock hazard, make sure to set the Function Selector switch to "OFF" and remove the test leads from the instrument before trying to replace batteries

CAUTION

- Do not mix new and old batteries.
- Make sure to install batteries in correct polarity as indicated in the battery compartment.

If the instrument is powered on, but the display blanks or **BATT** is shown on the lower left corner of the display, replace the batteries .

- Set the Function Selector switch to the "OFF" position.
- Unscrew and remove the battery compartment cover on the bottom of the instrument.
- Replace the batteries observing correct polarity. Make sure to use two new R6P batteries.
- Replace and screw the battery compartment cover.

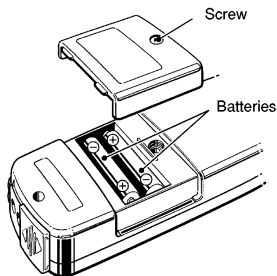

9. Optional Accessories

●MODEL8008 (For AC current measurement only)

Multi-Tran MODEL 8008 is designed to measure AC current up to 3000A or a large bus-bar or conductor with a clamp meter.

- Set the Function Selector switch to "400A".
- Select the AC mode with the AC/DC button.
- As shown in the figure below, clamp MODEL 2003A onto the pickup coil of MODEL 8008.
- Clamp MODEL 8008 onto the bus-bar or conductor under test.
- Take the reading on MODEL 2003A and multiply it by 10.

